

# Towards 6G 2030 Scenarios

June 2022  
[www.ericsson.com](http://www.ericsson.com)



# Needs in the 2030's



Trustworthiness

Trusted communication and computing for industry and society relying on critical information

Sustainable world

Communication and network as part of and enabler for sustainable development

Simplified life

Massive use of AI across systems for optimal assistance and efficiency

Application demands

Extended and new services requiring extreme connectivity performance

# Connecting a cyber-physical world

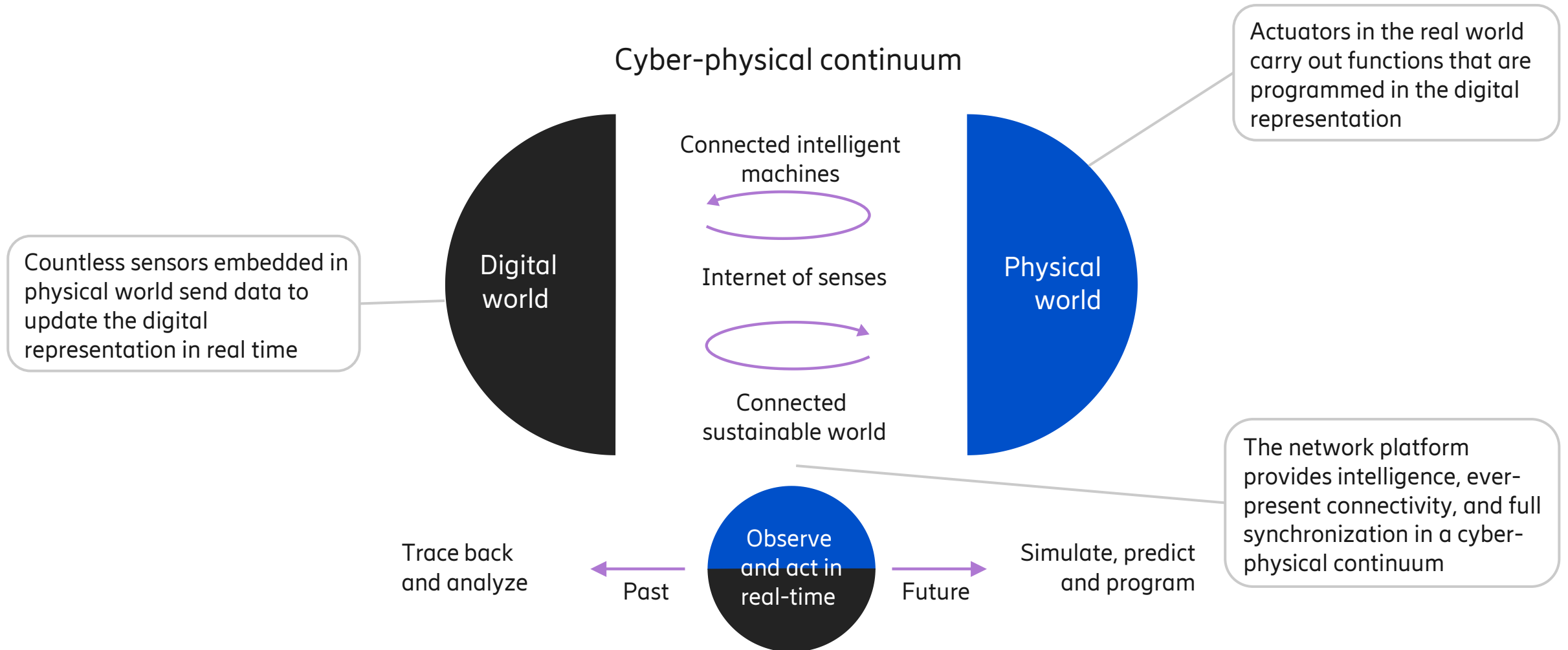

# What's in the cyber-physical continuum?



## Merged reality

- New ways of meeting and interacting with other people
- New possibilities to work from anywhere
- New ways to experience culture and scenes far away



## Massive digital twins

- Connecting all equipment and tracking material
- Using the network as a platform for many ecosystems
- Allowing accurate predictions and detailed control



## Situational awareness

- Sensing surroundings and locating objects
- Guiding robots and vehicles with digital maps
- Interacting with collaborative robots



# 2030 Scenarios



## Human and society use cases & needs

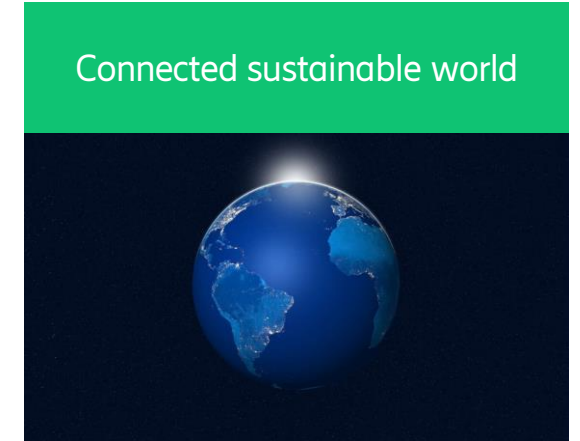

Use case focus

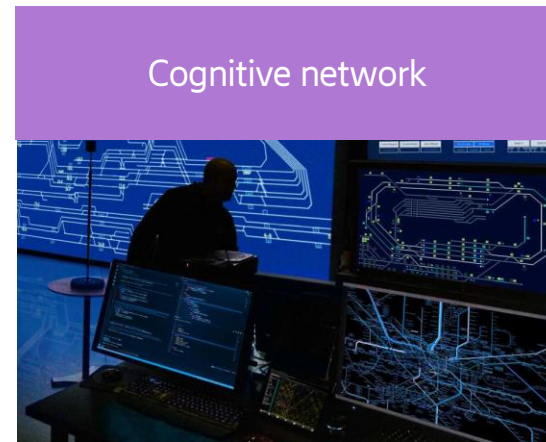
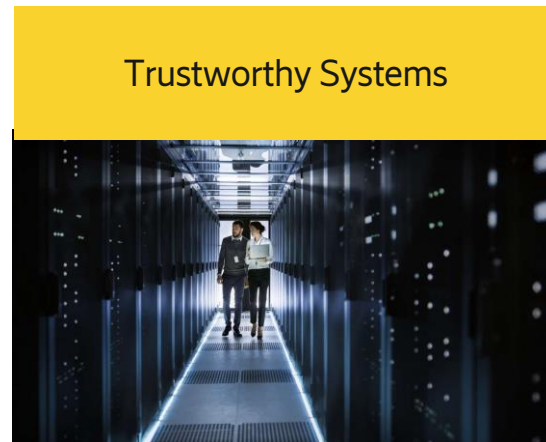
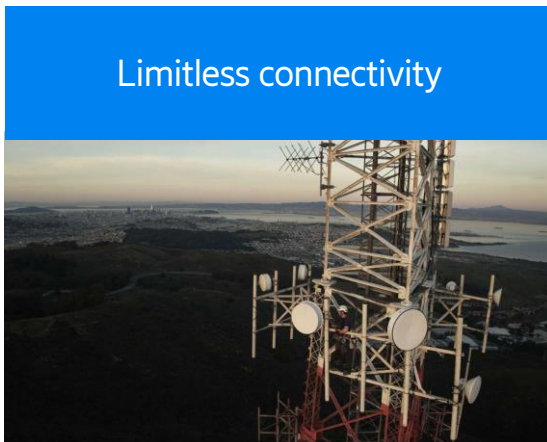

Technology focus

## Fundamentals of a 6G network platform

# Massive Multisensory Merged Reality



## What is offered

- Realization of virtual presence and immersive interactive applications
- Merged reality experiences
- All-senses involvement
- Holographic presence
- The portal to a metaverse experience powered by XR

## Network Requirements

- Very high rates
- Low latency
- High capacity for high density of users
- Edge compute
- Sensing to support spatial mapping
- Privacy preservation

# Interacting Navigating Robots

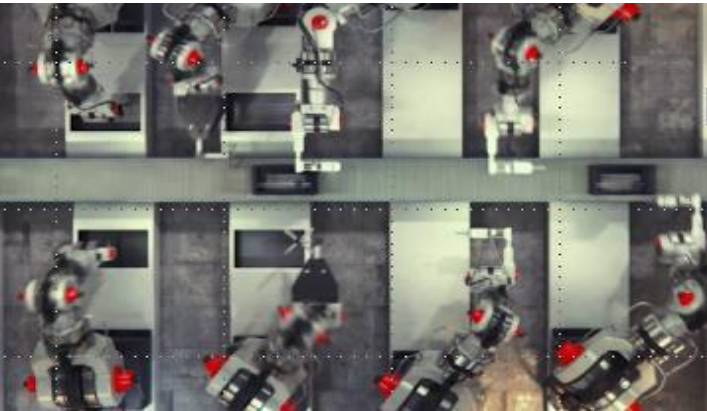

## What is offered

- Platform for sharing sensor data for smart cities
- Enabling connected autonomous vehicles/ robots to use external sensors
- Creating a sensor network for safe transports
- Communication among collaborative robots to coordinate their tasks

## Network Requirements

- Localization of devices
- High service area coverage
- Sensing of objects
- Digital mapping
- Very high service availability and reliability

# Collaborative AI Partner



## What is offered

- Autonomous systems and service robots interact, assist and collaborate with humans
- For industry, home and healthcare
- Cobots can coordinate activities between them, e.g. in factories, production

## Network Requirements

- Localization of devices
- Service area coverage
- High Data rates
- Low E2E latency
- Sensing of objects
- Very high availability and reliability



# Interactive 4D Map



## What is offered

- Digital 4D representation and aggregation of sensors and actuators
- Accurate description of history
- Detailed real-time-control
- Tool for predictions of the future (trends, faults, KPIs, etc.)

## Network Requirements

- Massive amounts of devices
- Real time and very low latency
- E2E data protection
- Support for zero-energy devices
- Compute offload
- Accurate positioning
- Availability and Reliability



# Precision Healthcare



## What is offered

- Connecting a body area network of in-body and on-body devices
- Reliable and secure health data handling
- Real-time monitoring and online analysis
- Predictive medicine

## Network Requirements

- Service reliability
- Maintenance free low energy sensor devices
- Support short survival time
- Privacy preservation
- E2E data protection



# 2030 Scenarios



## Human and society use cases & needs

The Internet of Senses



Connected Intelligent Machines



Digitalized & programmable physical world



Connected sustainable world



Use case focus

Limitless connectivity



Trustworthy Systems



Cognitive network



Network compute fabric



Technology focus

## Fundamentals of a 6G network platform

# Network Adaptability

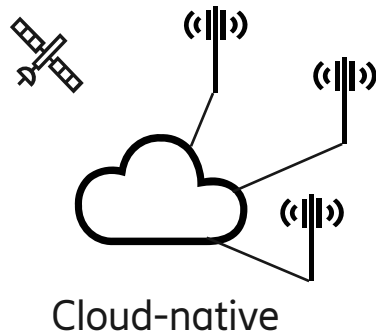

## Network architecture optimized for cloud

- Based on a common cloud platform and IT
- Fully service-based architecture
- Enhanced functional separation
- Enabling optimization and simplification

## Flexible and dynamic networks

- Integration of new types of access nodes
- Versatile programmable transport for cost effective densification
- Addressing needs from enterprises and verticals

## Programmable devices and network

- Adjust to new deployments and use cases
- Faster TTM for new services & features, DevOps
- Dynamically deployable AI/ML agents

# AI for Air Interface



AI for PHY

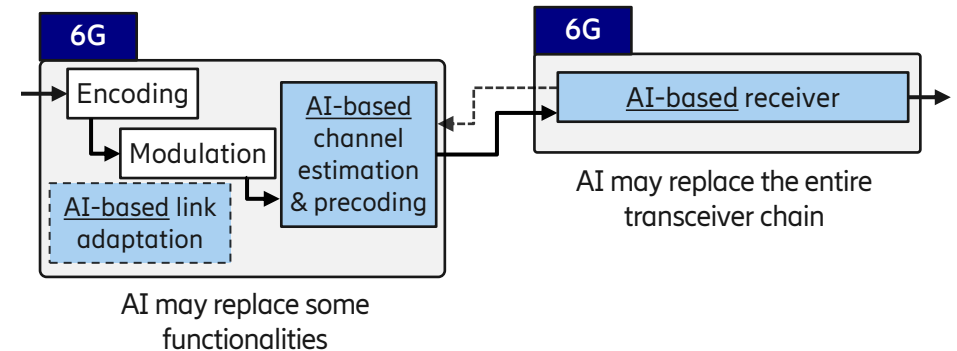
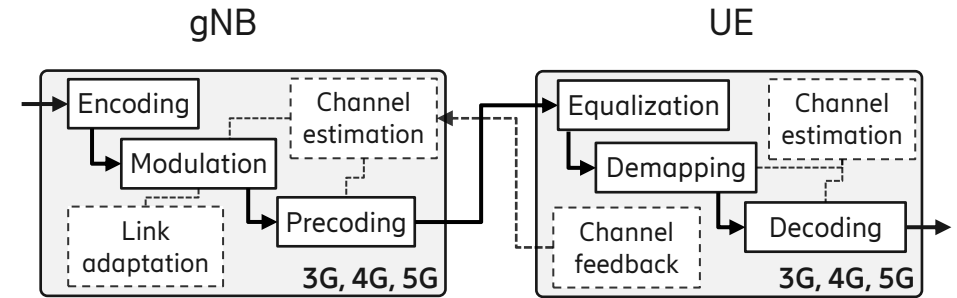

## Air interface

- Learn air interface functionality instead of using hand-crafted models
- Embrace non-linearities and limitations- and adapt dynamically
- Optimize parameters and automate configuration

# New Network Topologies

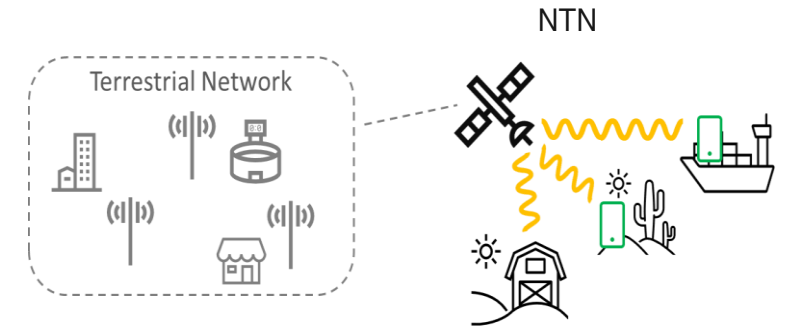
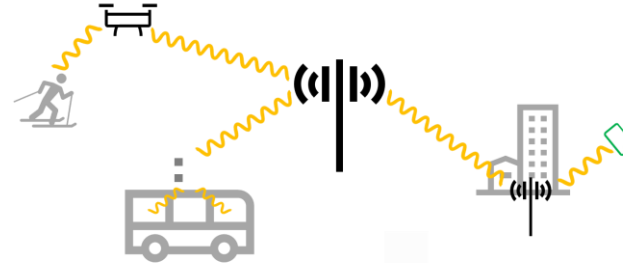
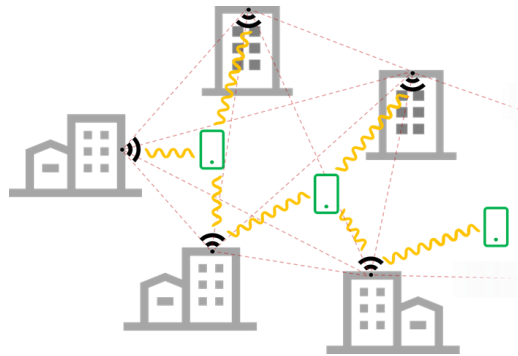

## Multi-point connectivity

- Number of tightly coordinated NW nodes, D-MIMO
- Simultaneous connectivity to multiple nodes

## Multi-hop connectivity

- Integrated Access and Backhaul like relaying, mobile relay nodes, air-borne nodes
- Lower-cost dense deployments, and temporary deployments

## Satellite component

- Global coverage and enhanced availability
- Both cellular and satellite-specific bands

# Radio Spectrum

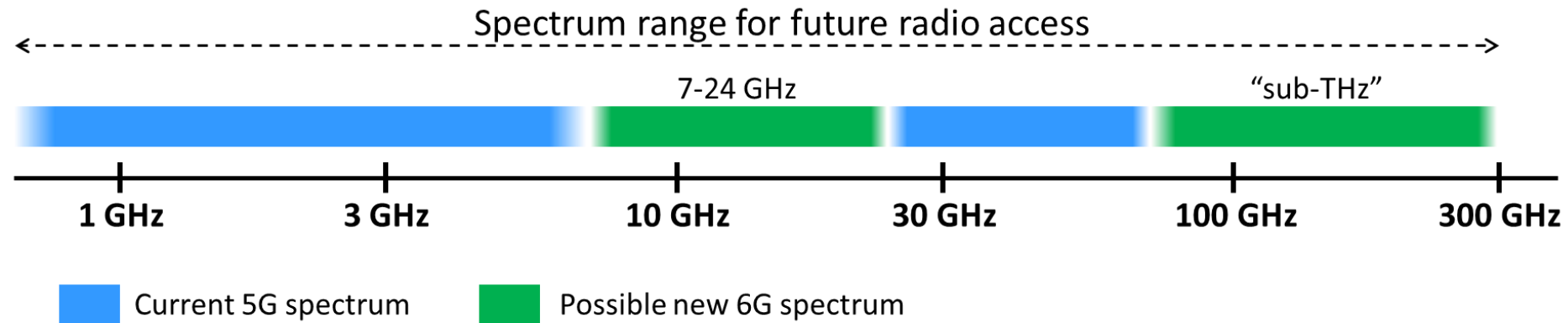

## Future 6G radio access - from sub-GHz to beyond 100 GHz

- Capacity expansion in sweet spot 7-24 GHz
- Lower frequencies needed for wide-area coverage of future 6G services
- Very high frequencies for extreme data rates in specific scenarios
- Co-existence with legacy technology like 4G LTE, 5G NR for smooth migration to 6G

# Network Sensing

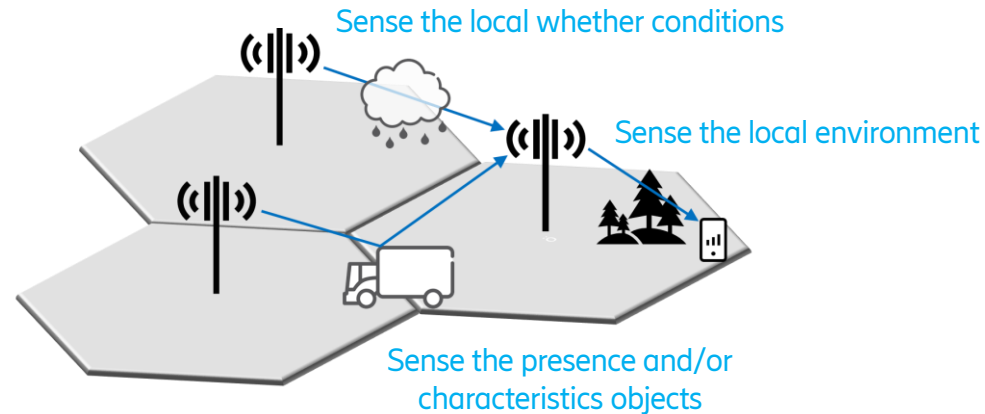

## Sensing as part of the network

- Reuse the communication spectrum and infrastructure for sensing
- Low-cost introduction of sensing functionality
- Benefit from huge number of co-operative network nodes

## Sensory information

- Externally to enable new and enhanced services
- Internally to enhance and protect the network
- Sensing functionality for immersive experience



# Embedded devices everywhere

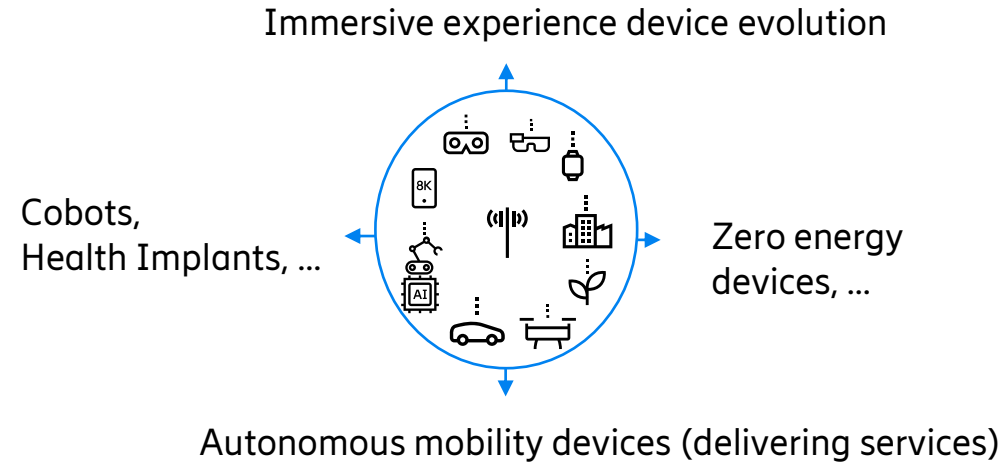

## Enabling connectivity everywhere

- Legacy devices (smartphone, NB-IoT sensors, ...).
- Emerging devices (VR glasses, zero-energy devices, health implants, ...).
- Offer rich sensory experiences by a cluster of collaborative devices with varied ownership.

## Immersive interactive devices

- Enable natural and intuitive interaction with digital and mixed digital-physical world.
- Network provides authentication, resource management, edge compute etc. in addition to setting up the application aware device clusters.

# "Zero-energy" devices



## Devices harvesting ambient energy

- From solar, temperature, vibrations, RF, ...
- "No need to change battery"
- Enabling sustainable asset trackers, sensors for mass deployment, ...

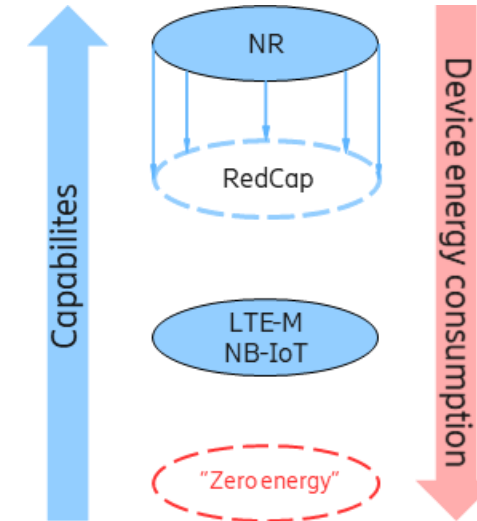

## Design challenges

- Very small amounts of energy available, complete redesign of the air interface needed
- PHY: Waveform suitable for Rx/Tx device imperfections, crystal oscillators likely not feasible
- Mobility: Current mobility mechanisms cannot be afforded from an energy perspective
- Security: Power-efficient security mechanisms

# Network compute fabric



## Dependable compute & storage

- High availability & capacity
- Respond in real-time
- Defined levels of reliability, availability, and resiliency
- Run in an energy-efficient manner

## Unified, fluid computing across the fabric

- Seamless & dynamic deployment of applications (on central cloud, edge, devices)
- Balance compute & energy use and performance & cost
- Let workloads follow mobile users
- Allow processing close to data sources and data consumers

Ubiquitous compute resources fully integrated with the network to complement connectivity

Enabling broad collaboration in federated ecosystems

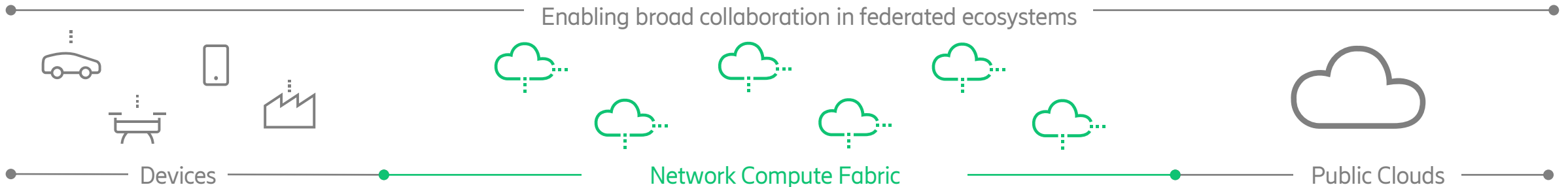

# Cognitive Networks



## Intent-based management

- Declarative intents to specify requirements and constraints
- Learning agents to execute network assurance & control.

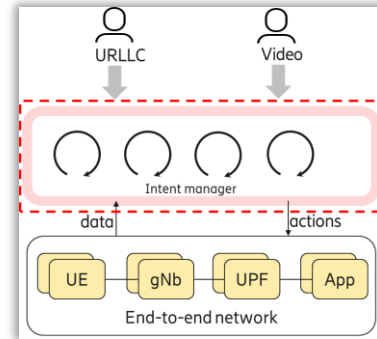

## Distributed intelligence

- Smart algorithms guide all network operations
- Distributed & centralized AI to optimize performance.

## Data-driven architecture

- Make data accessible for applications.
- Use data to optimize performance and automate operations.

## Continuous learning

- Continuously monitor network performance
  - Shift from reactive to predictive management
- autonomous operations

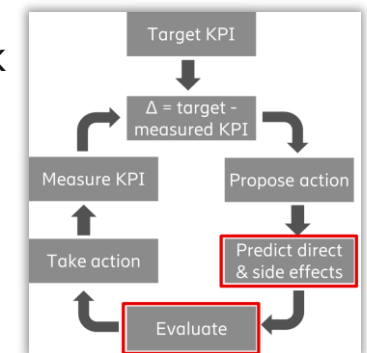

# Trustworthy Systems



## Security assurance

- Enhanced assurance for the whole product lifecycle
- ML/AI capabilities for threat detection and response

## Secure identities & protocols

- Root of trust-based identities
- Privacy-preserving protocol stacks
- Confidential Computing for network slices

## Service availability

- Efficient and robust resource provisioning for critical services
- Observability of network parameters exposure for E2E availability

# Capabilities



“Classical” capabilities still important

New capabilities for emerging use cases

Cost efficient and sustainable

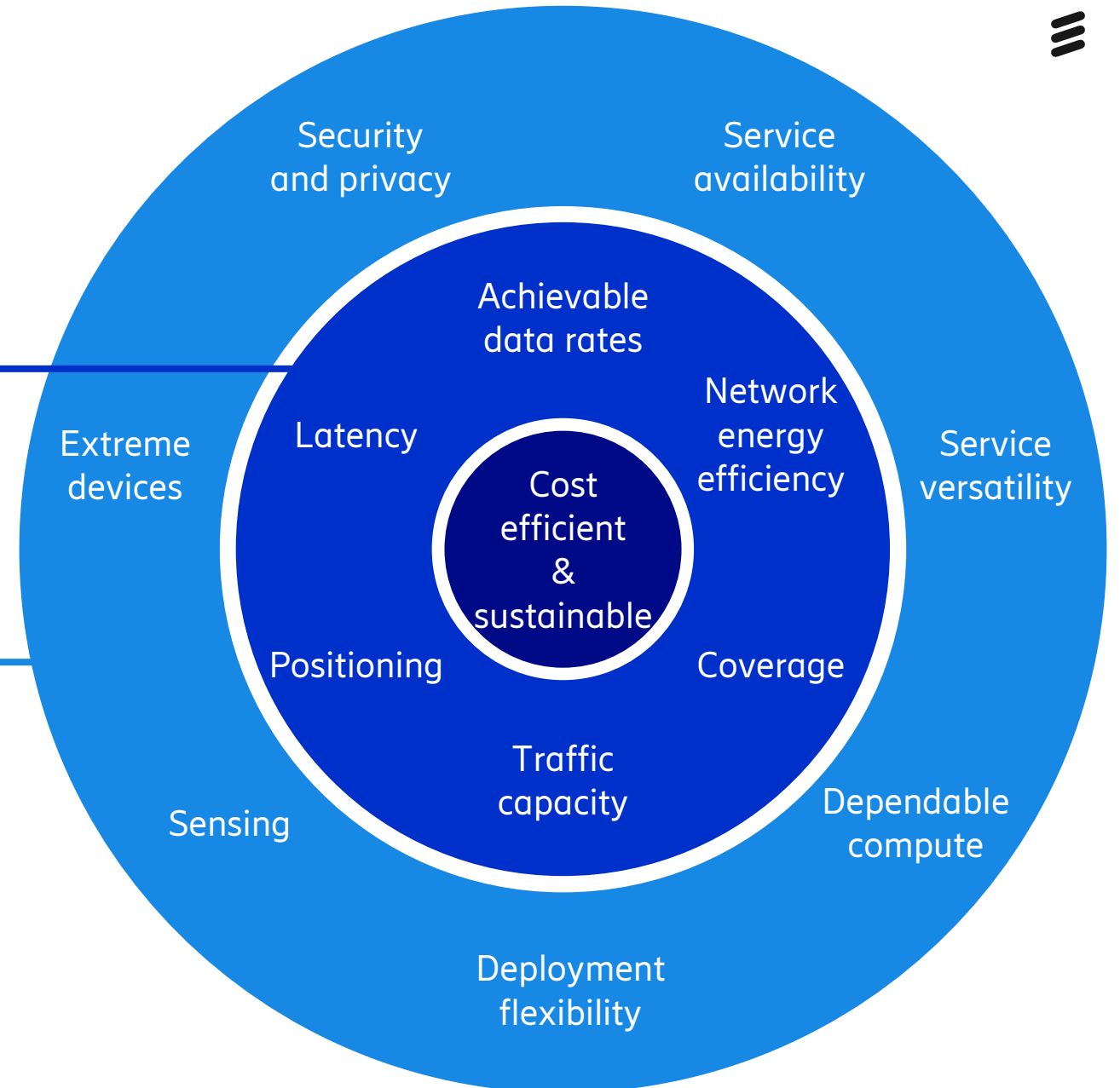

# 6G industry timeline

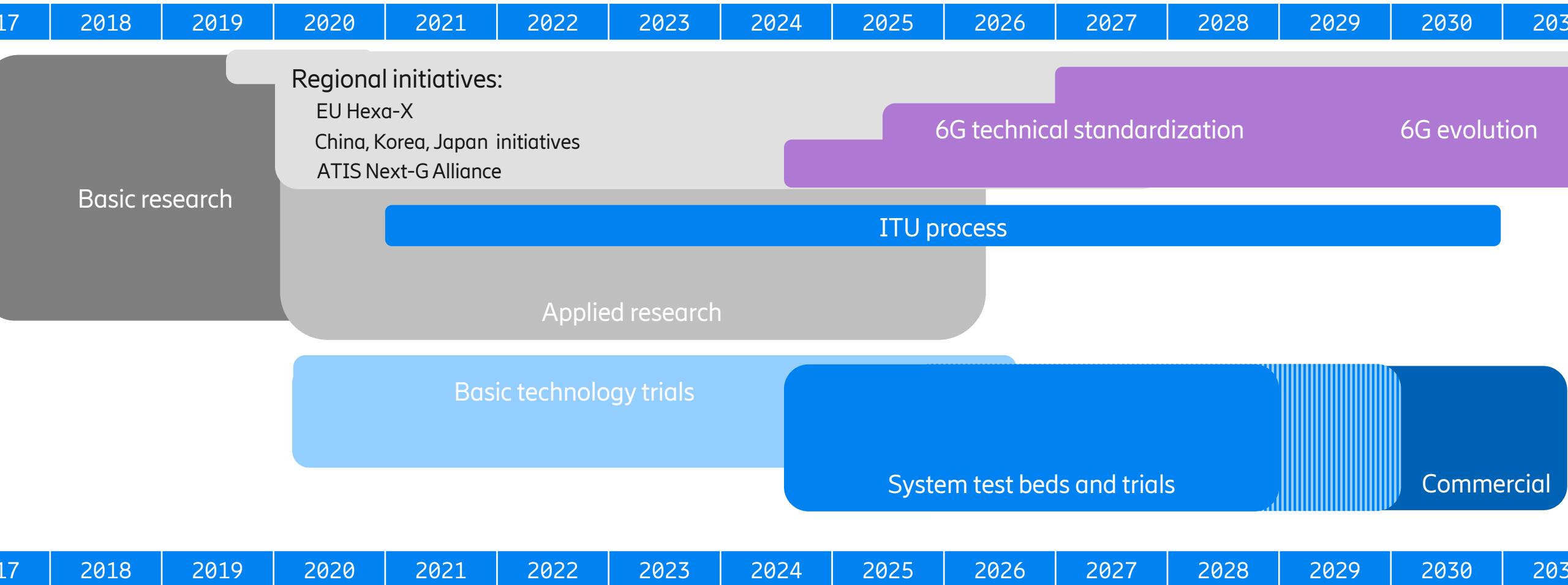

# Connecting a cyber-physical world

## 6G white paper



Released in February 2022

Presents Ericsson's 6G vision for 2030 - a broad view covering our ongoing explorative research

<https://www.ericsson.com/en/reports-and-papers/white-papers/a-research-outlook-towards-6g>

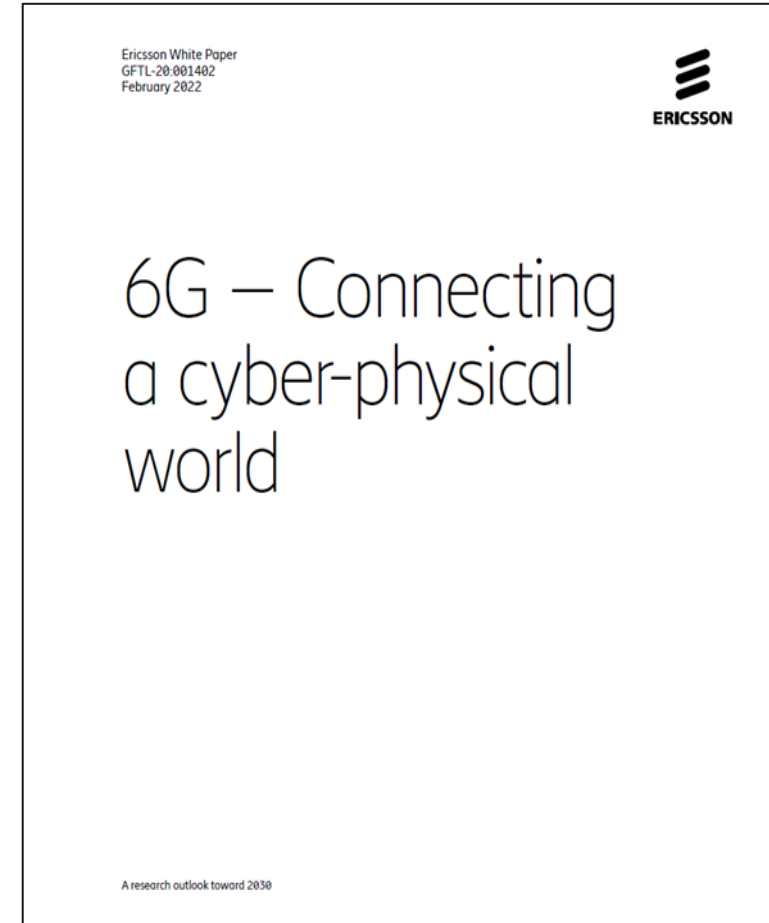



# 6G Network Platform

*A trusted platform delivering ever-present intelligent communication including connectivity, data, and compute.*

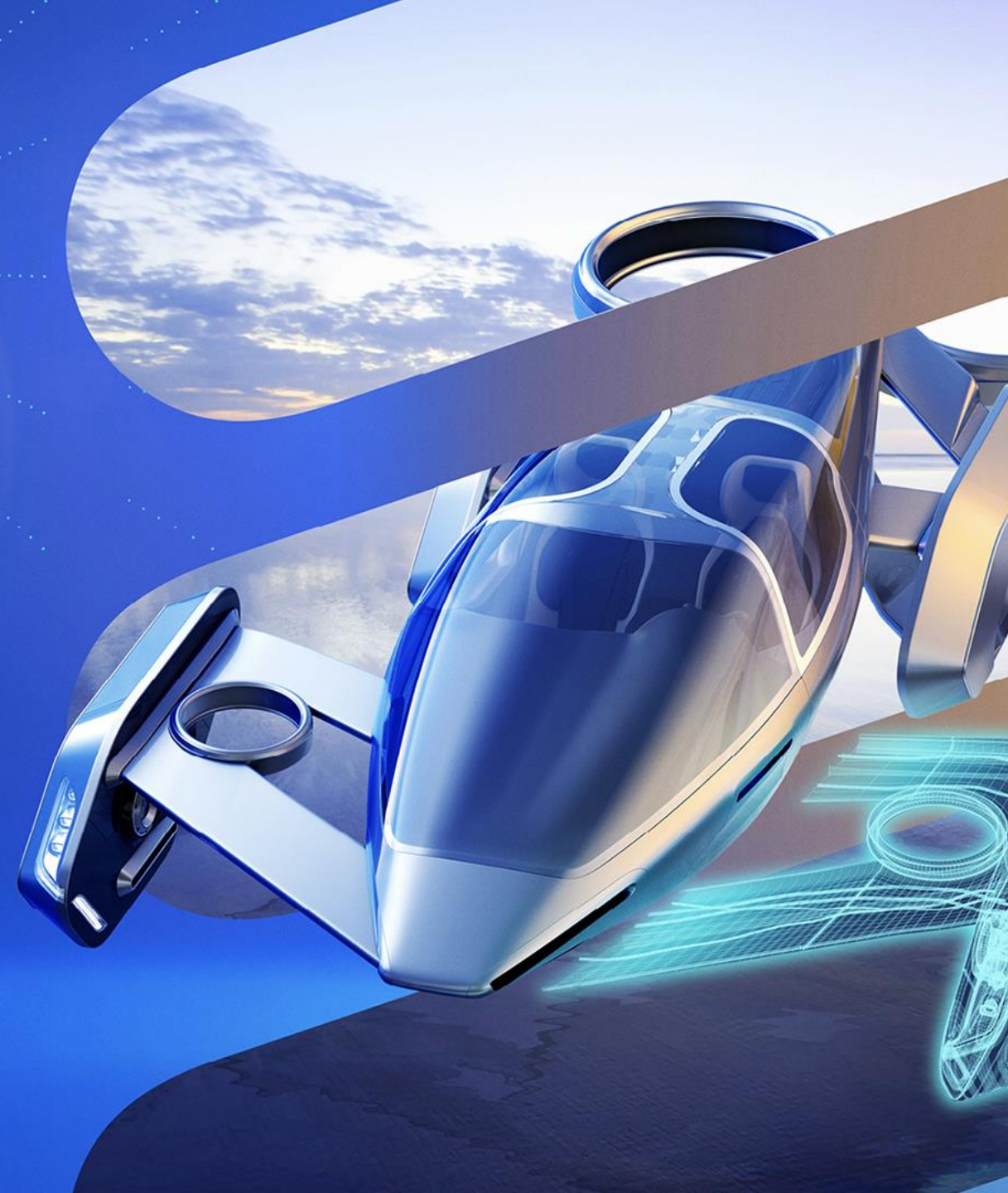



# Imagine Possible

<https://www.ericsson.com/en/6g>